

LIMITED EDITION LIMITED EDITION LIMITED EDITION

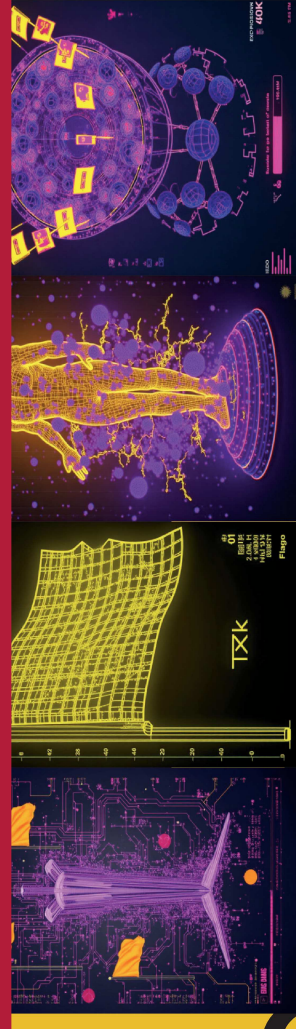

POWER UP YOUR BRAIN WITH THE FLAGS

NEW RESEARCH-
PEOPLE ARE FLAGS!

MAKE YOUR
VERY OWN FLAG

HIDDEN

STEAL ME
FLAG

WISDOM

REVEALED

NEVER BE
FLAGLESS
AGAIN WITH
THESE
SIMPLE TIPS!



Field

CONQUER

FLAGHACK
RELEASE
IMMINENT...
CAN YOU
HACK IT?

100% REAL!!!



A HIPPIE STOLE THIS FLAG, YOU
NEVER GUESS WHAT HAPPENED NEXT!

How they stole
your flag and
how to get it
BACK

ACHIEVE ENLIGHTENMENT
OR YOUR MONEY BACK

EVERY
PAGE
SCIENTIFICALLY
VERIFIED
BY TRULY
O-
ERS

SACRED FLAG
CHAKRAS
EXPLAINED,
EXPLORE ALL
SEVEN ALONE
OR WITH A
FRIEND

FIRESTARTER
FREE
FREE



FLAGS-FLAG

Find Your
Flag



FLAGISTAN
AWAITS



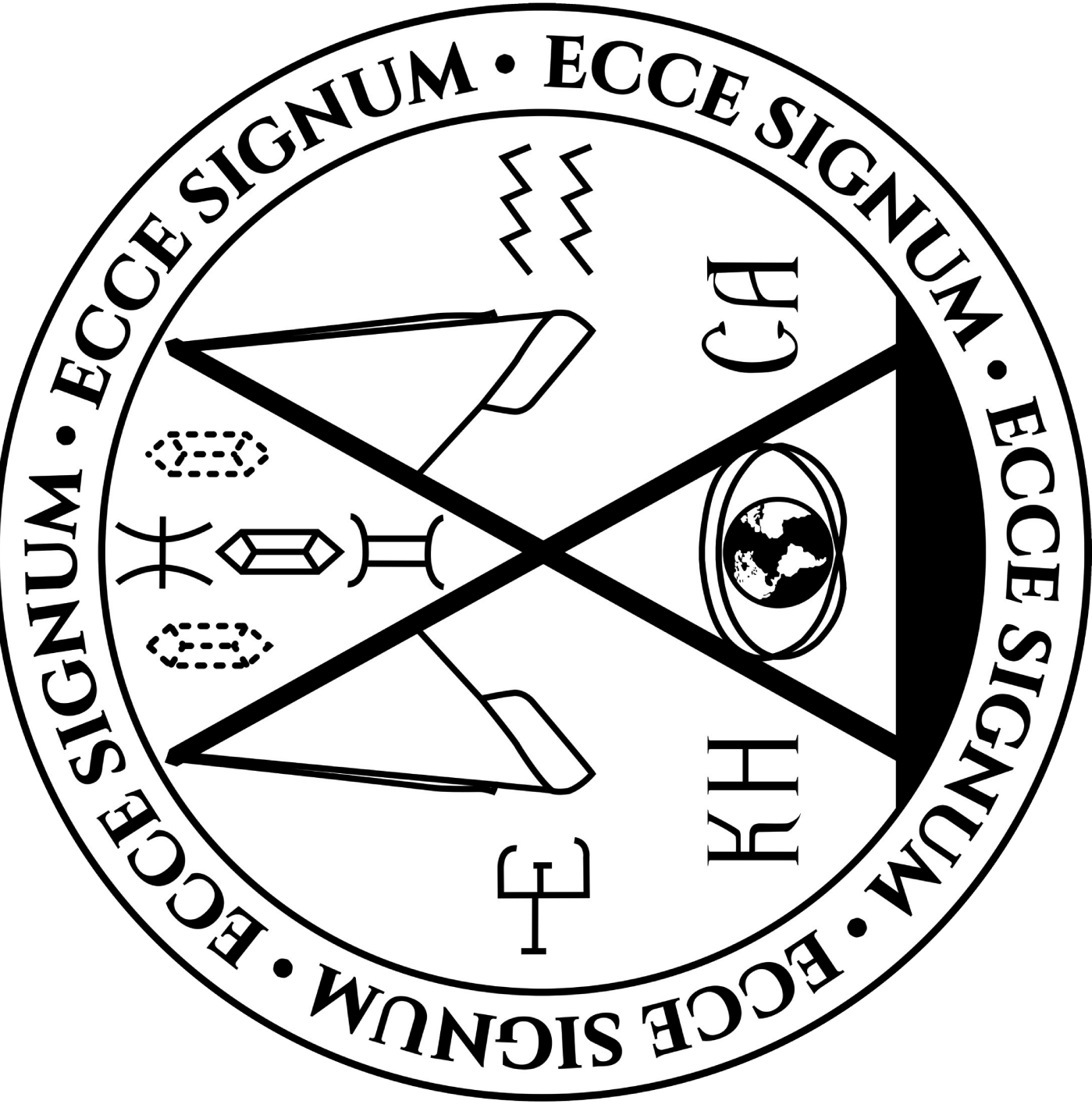

This magazine was produced by the International Vexillomancer's Guild in July -349 for distribution in the years 1973, 2000, 2024, 2476, 2576, 3296, -502, -399, -312, -71, -2, and -1.

All current, past, and future members of the world, possible members of the world, impossible members of the world, members of other worlds and members of no worlds, are members of the IVG. If you wish to claim the benefits of your membership you can do so by visiting www.vexillomancy.org

Contents

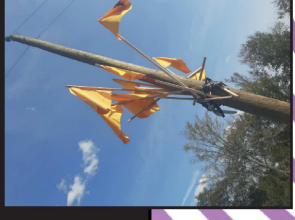

3 FLAGS

7 FLAGS

12 FLAGS

15 FLAGS

23 FLAGS

24 FLAGS

31 FLAGS

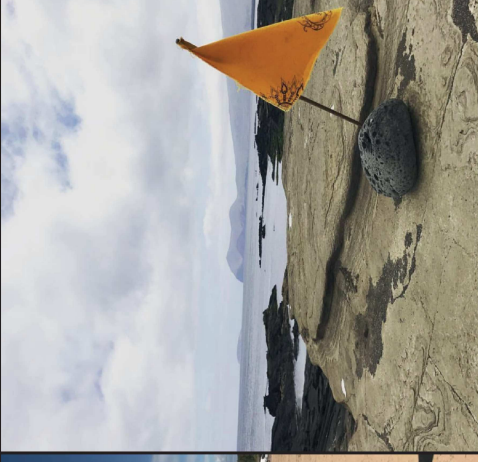
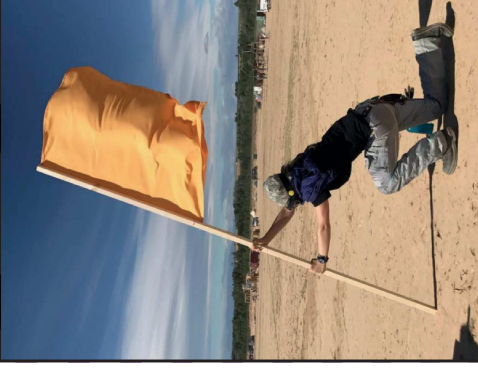

LICENSE

All content herein is published under the Flag License 4 (FL4.G) - If you read this content you MUST modify and/or distribute it. If the means to do so are at your disposal, you are obligated to distribute this work into the past. Strict consumption of this work is forbidden. If found please use. If lost please return to temple. Any person found to be in possession of this work without modification or distribution shall have this work stolen. If you have stolen this work then these terms also apply to you. All copies of this work and all content therein are considered stolen. If you feel so compelled, you SHALL burn this work. You may not put your name in this work, only the names of others. This work may not be considered art. Calling this work art is strictly prohibited. Thinking that this work is art is considered thought crime. This work is provided without any warranty or guarantee, except for the guarantee that this work is defective. You may not augment this work with any content that is not stolen or that will not become stolen upon said augmentation; failure to abide by this condition will result in said work being stolen. Digital and physical piracy of this and other all other works is strongly encouraged. Any derivative of this work must contain this same license but with different terms. The reader SHALL debate this work in whole or in part, including parts of this work not containing this license, and including parts of this work not yet included in this work, you agree to understand and follow the terms and conditions of this license. Rejecting this work does not undo you from this contract. This contract is not voided upon any cation concealable or inconceivable. By accepting this contract you retroactive accept it in the past as well as the future.

FLAGS
FLAGS
FLAGS
FLAGS
FLAGS
FLAGS
FLAGS
FLAGS
FLAGS
FLAGS

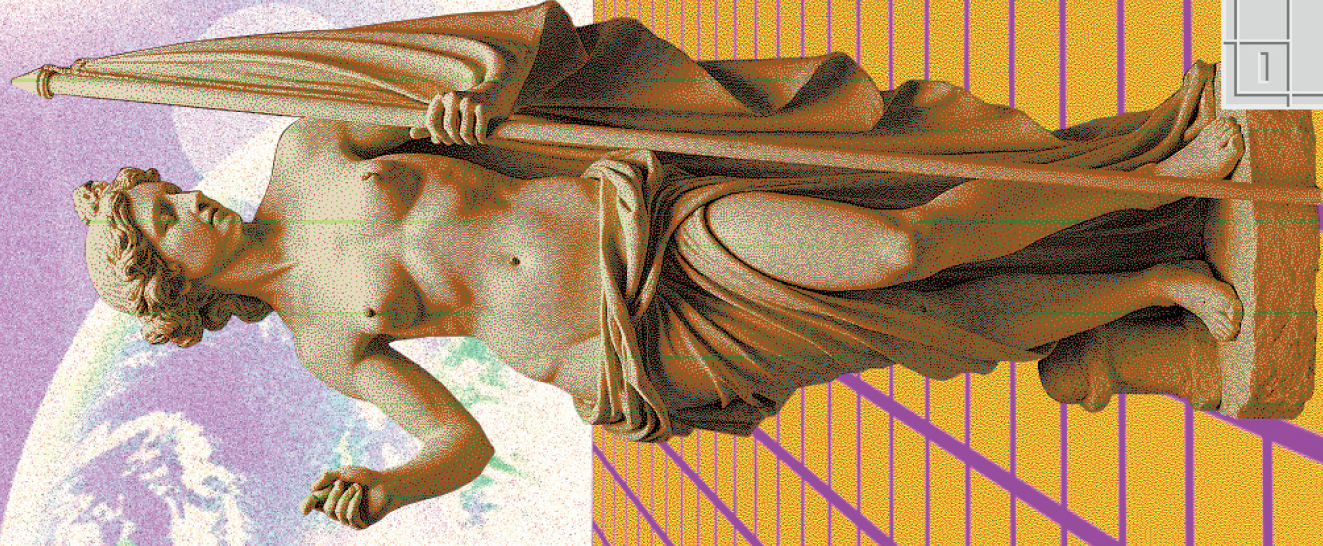

ERROR: FLAGS MUST BE MOVED

 **FLAGS** were not moved because a buffer overflowed.
Move the flags?

HOROSCOPE

Pisces

A yellow flag rises in your emotional and spiritual world, signaling a flow of positive energy. Movement in your inner life brings new insights, healing, and good fortune. This week, trust in the flow of your intuition—it's guiding you toward breakthroughs and emotional clarity. Ride the current of good luck.

Capricorn

A yellow flag flies in your art projects and long-term goals, signaling progress and success. The movement you've been working toward is finally happening, and good fortune is on your side. This week, the effort you've put in yields tangible results, moving you closer to your ambitions. Trust the flow of advancement.

Leo

A bright yellow flag signals that it's time to take center stage. Momentum is building around your ambitions, and now is the moment to act. Good fortune follows your bold moves this week—your natural leadership will guide you to success. Trust the wind at your back, and stride forward with confidence.

Scorpio

A yellow flag signals forward motion in the deeper realms of your life. Transformation and insight are on the horizon, and these shifts bring good fortune. The mysteries you've been exploring now lead to revelations that propel you forward. Trust in the momentum of change—it's leading you somewhere powerful.

Gemini

The yellow flag in your sky signals quick movement in your social and intellectual life. Conversations, ideas, and connections flow freely, bringing you luck and opening new doors. The pace is picking up—lean into it! Fortune favors your curiosity, and new insights will push you forward in exciting directions.

Sagittarius

The yellow flag waves you toward new horizons. Movement is key this week—whether it's physical travel or the expansion of your mind, your path is blessed with good fortune. Seize the opportunities that come your way, as the winds of luck are carrying you toward adventure and discovery.

Virgo

A yellow flag waves as a sign of successful progress in your plans. Your attention to detail is paying off, and this week, the pieces fall into place. Movement is subtle but powerful; trust that the steps you've taken are bringing you closer to your goals. Fortune smiles on your methodical approach.

Aquarius

A yellow flag signals positive shifts in your ideals and creative pursuits. Movement in your vision brings fresh opportunities for innovation and growth. The winds of good fortune blow in your favor this week—trust your unconventional ideas to take flight. Your unique approach will carry you toward success.

Taurus

A yellow flag heralds a period of growth and success. Your hard work is paying off, and now things are shifting in your favor. Movement may feel slow at first, but this is the start of lasting progress. Trust the signs—your steady pace will lead to prosperity and abundance.

Cancer

A yellow flag rises over your personal life, indicating that positive change is on the way. Movement in your emotional world brings new possibilities for connection and healing. The winds are shifting in your favor, encouraging you to nurture these transformations with an open heart. Good fortune comes through those you love.

Aries

A yellow flag waves, signaling that it's time to charge ahead. Your instincts for bold moves are right on target this week—embrace the momentum. The universe is cheering you on to take action and trust in your good fortune. Opportunities are not only within reach, but they're moving toward you.

Libra

The yellow flag heralds harmony and balance coming into your relationships. Movement in partnerships—romantic, professional, or social—is aligned with good fortune. Now is the time to make that decision or extend an olive branch. Positive energy is flowing between you and others, bringing resolution and cooperation.

FLAGSGSFFLAGS

FLAGSGSFFLAGS

FLAGSGSFFLAGS

FLAGSGSFFLAGS

FLAGSGSFFLAGS

FLAGSGSFFLAGS

FLAGSGSFFLAGS

FLAGSGSFFLAGS

FLAGSGSFFLAGS

FLAGSGSFFLAGS



FLAG
BIRTH-
DAYS

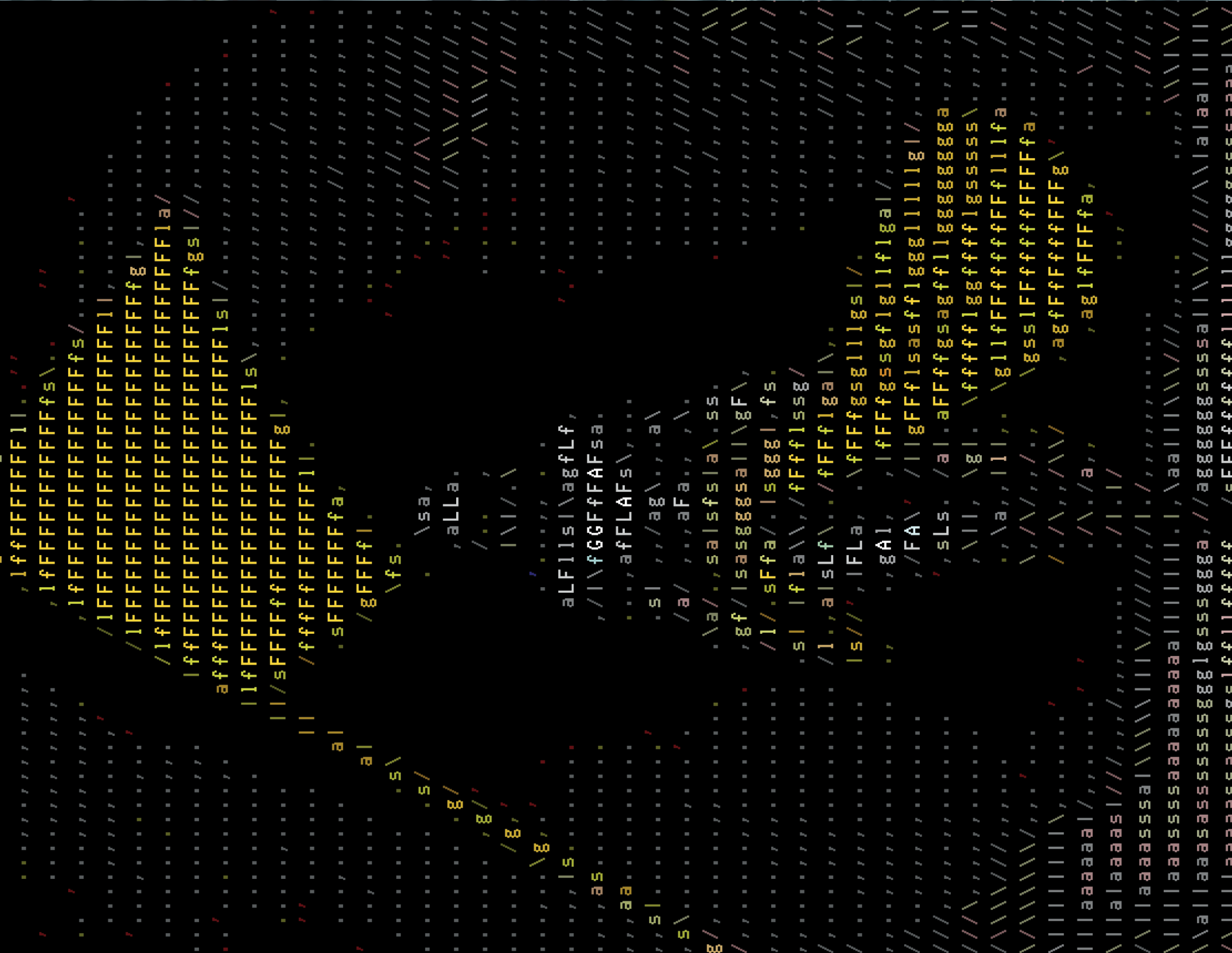

**Going
places?**
*We've been
there.*



And we will be there with you every step of the way. It is all too easy to get lost in the fold. Here at KVC, our labs have performed hundreds of highly acclaimed studies tracking ley lines, time fragments, and Flag patterns. As the industry leader in vexillomantic research we can provide you with direction and planning from experts, ensuring that your Flag reaches its destination. Our guidance is free, the direction we provide is its own reward. Visit us now and receive your consultation.

EASY CROSSWORD

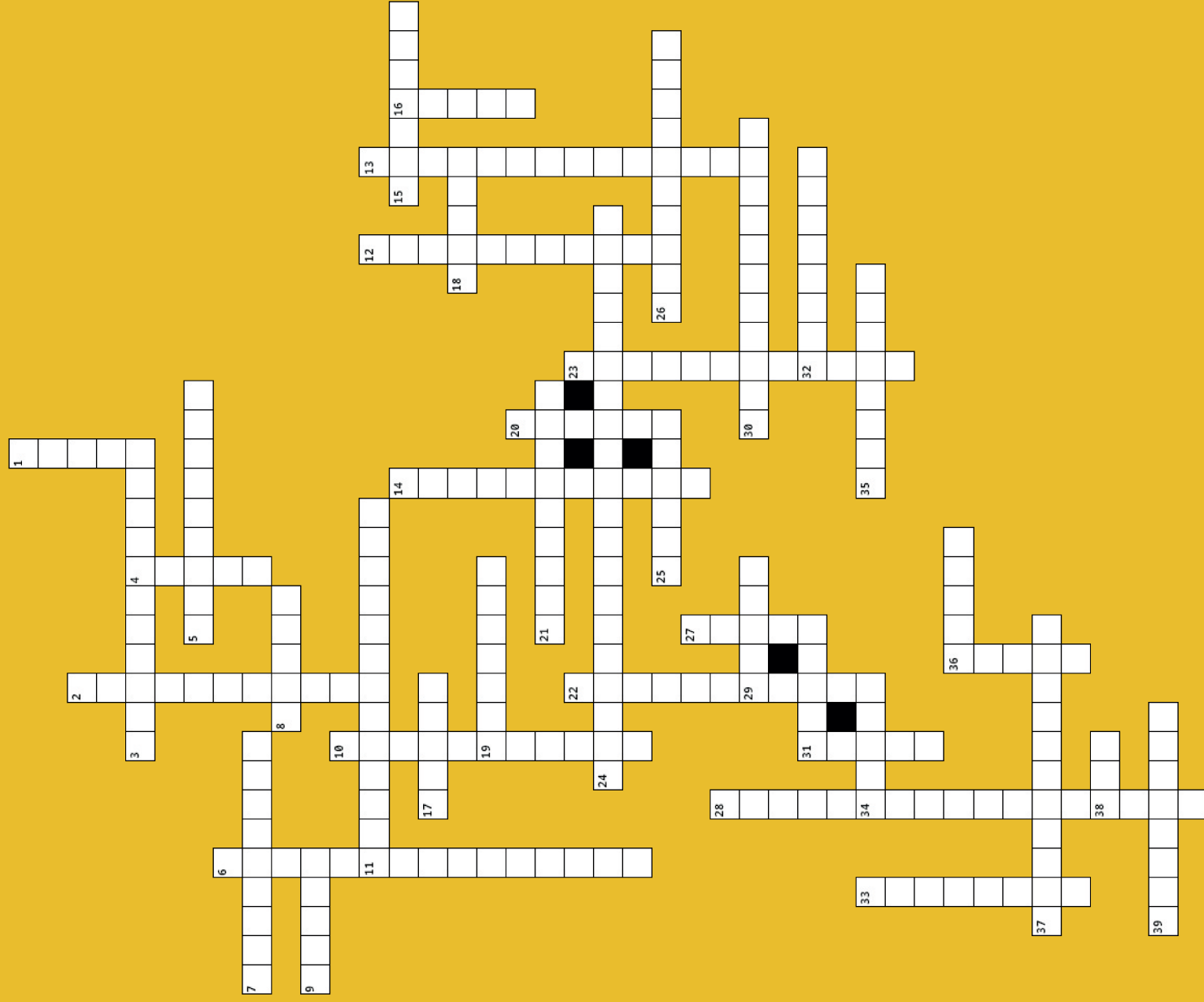

beginners tip:

Complete the crossword puzzle to win! With our new design you dont even need hints! Visit Ian's Massive Ego to check your answers.

HACK THE FLAGHACK

Get ready to dive into uncharted territory with FlagHack, the pioneering adventure game that's about to set the gaming world ablaze! Imagine a realm where dungeons are explored not with traditional weapons, but with the mystical power of vexillomancy and yellow flags. As you venture deep into the unknown underground, you'll wield these flags to solve intricate puzzles and unlock secrets that defy the limits of imagination. With its innovative blend of strategy and magic, FlagHack is poised to redefine adventure gaming, offering a groundbreaking experience that will captivate your mind and challenge your every move. Get ready to explore a world where the flags you wield can alter your destiny! Can you make it to the Time Crystal and reshape the very fabric of reality?

Fear not intrepid adventurer, we sat down with the programmers of FlagHack and were given the opportunity to play a prerelease and also received insider information on strategy and more. In this issue, we'll be your guide through the perilous depths of FlagHack, arming you with expert tips and tricks to help you survive its daunting challenges. From mastering the arcane art of vexillomancy to learning how to deploy your yellow flags for maximum effect, we've got the strategies you need to conquer even the most treacherous puzzles. But that's not all—along the way, we'll introduce you to the fascinating cast of characters who inhabit this underground world, from cryptic sages to flag-wielding foes, and give you a sneak peek at the unique and mysterious locations you'll traverse. Whether you're braving the eerie Flagstone Caverns or navigating the labyrinthine Banner Halls, this guide will ensure you're fully prepared for the adventure of a lifetime.

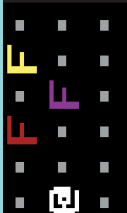

Do not be deceived by the anti-flag

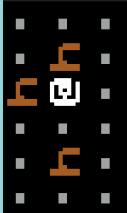

Hippies can be surprisingly useful

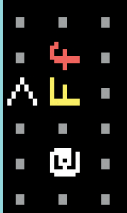

Fires can be used to burn flags



the effects of gear are different each time you play



You will lose many times in your journey, but dont give up.

FLAGS

Flags are the most important item class in the game and the one that you will spend most of your attention on. Make sure to pay attention to the color of the flag and inspect it for writing or glyphs either on the cloth or the staff itself



DRINKS

Drinks are vital to staying alive, but be careful before you drink strange liquids you find lying around on the ground. The only exception, is the "Unopened Clear Plastic Bottle" which is (normally) always water. Other drinks can have a variety of effects, but you will have to try them or used advanced techniques to find out what they are

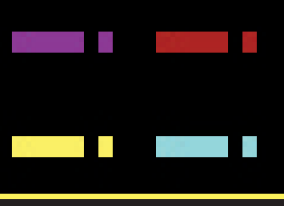

FOOD

Food includes all edible substances, even those normally not thought of as food. Adventuring builds up quite an appetite, and you will need to eat fairly often. Be careful accepting food from strangers, as it can have unforeseen consequences... but doing so is most likely the only way you will survive unless you are radically prepared.



SWAG

Swag includes several different types of miscellaneous accessories. From necklaces to patches. The way you wear them depends on the swag itself and the clothing you have equipped.



WRISTBANDS

Wristbands are similar to swag except that they stay on your wrist and have a different effects. In addition to their magical effects, they can be used to gain entry to spaces in which you would not normally be allowed. Choose your wristbands carefully, you can only wear them once, and in order to remove them you will need scissors.

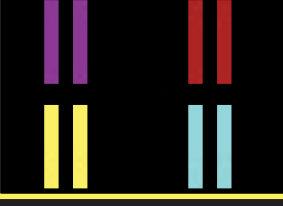

TOOLS

Tools are almost always worth grabbing when you come across them. They are the most varied of the item classes, the main aspect that links them together is that almost all tools can be applied. Some tools have a limited number of uses, while some will last forever.



Common Item Categories

Basic Tips



UPSTAIRS

You can use these to ascend floors in the dungeon



DOWNSTAIRS

You can use these to descend floors in the dungeon. Note: the downstairs on the first level is in the effigy and does not have this appearance



TRAPS

These are environment tiles that have miscellaneous effects. They are mostly harmful.

Environmental Tiles

Burner

The proverbial jack of all trades, you are moderately radically self-reliant, although it would seem you forgot your toothbrush. (I'm sure nobody will notice). This is the class that new players should try first. You will start with decent gear, some food and some water, and no real drawbacks.

Crystal Tuner

You emerge from your sound bath, refreshed, ready to spread good vibes. You can intuitively see the ley lines, and you start with several crystal fragments and an increased proficiency in using them, as well as an increased vibes reservoir. However the wrong move could easily misalign your chakras, and alcohol harshes your vibe so you will have to find another way to stay hydrated. This is a class for advanced players.

DJ

You came to blast some sick psytrance, but unfortunately the fascist sound team has implemented "quiet hours" and all the DJ slots seem to be full. It doesn't matter though, you have your own speakers and plenty of earplugs for anyone who complains. This is a difficult class.

Flagmaker

You came here to make flags for these ungrateful hippies. You have all the tools to make flags, and a lot of them. The problem is that, in order to make room for flags you had to leave most of your supplies at home. This is probably the 2nd easiest class if you can get lucky and find a few supplies at the beginning.

Pyro

Some people say you like fires a bit too much, but isn't that what the burn is about? You start with a gallon of gasoline, multiple lighters and a whole bottle of fireball, as well as some nice flame-resistant clothing and a better fire prop than the rest of the classes. This class is not too difficult for intermediate players and having many lighters is surprisingly advantageous

Ranger

"Hey, over, I have a question, uhmmm... does anyone know where my dirt went? If you find them send them over to me... thanks" You are seasoned. You know what you are doing. You are the adult. The downside is that you are immune from most positive food status effects. The upside is that you start with collectible gear, including a radio (don't forget to hold down the button to listen to incoming transmissions). Most hippies will also be more likely to listen to you. This class is more difficult than it seems, and we recommend it only for advanced players.

Vexillosaint

Deep in Flag-psychosis, your brain itself is like a Flag, you seem to intuit everything instantly. You move swiftly. But like a flag if you stand still you seem to lose your energy. You must be quick, but you intuitively understand the inscriptions on Flags, reducing a lot of tedious guesswork for the experienced player. A good class for speedrunners and highly advanced players.

BE ON THE LOOKOUT FOR YELLOW FLAGS

You never know where you will find them, but one thing is for sure, they are important to completing the game, so keep your eyes peeled for them.

MASTER BASIC VEXILLOMANCY

As you know, the power of the flag depends on its positioning and its movement. Don't forget to move the flags.

BURN A FLAG FOR SPECIAL EFFECTS

Although flags are useful to move they are also useful to burn. Make sure you can maintain a healthy balance of burning and moving the flags

TALK TO THE HIPPIES

Hippies underground can be very useful in your flag quest. Some of them may even join you on your adventure.



The Dreaded Flag Eater



An Acid Cup



A Lesser Egregrare



A Greater Egregrare

DO NOT LET THE HIPPIES FOOL YOU

Hippies, although sometimes useful, can be very crafty. Many of them will try to steal your flags. Some will try to mislead you in order to scavenge your flags and leave you flagless when your journey ends.

WRITE ON THE FLAGS

As you journey deeper, you will find flags that have incantations and symbols written on them. Pay close attention to the effects each of these have

FIND THE TIME CRYSTAL

This is your main goal, and you should not lose sight of it. But ultimately when you find the time crystal your quest is only beginning.

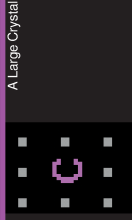

A Large Crystal

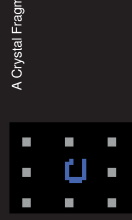

A Crystal Fragment



A fire



A hippie

DO NOT MOVE THE ANTI-FLAG

It may be tempting, but do not move the anti-flag. The game will try every trick in the book to get you to move it, but if you do then you will soon find yourself in a bind. We suggest not even thinking about these heretical flags.

CREATE YOUR OWN YELLOW FLAGS WHEN YOU RUN LOW

A flag is not too difficult to create, although you do need the tools and materials. As a special hint, you are able to dye fabric, so make sure you pick up any dyes you find.

READ THE FLAG PATTERNS

Some puzzles require deciphering the intricate patterns on or of flags for clues. Understand the different motifs to avoid deadly traps.



A Hammer

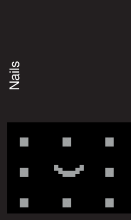

Nails



A Wooden Staff

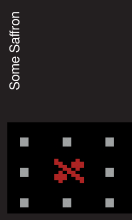

Some Sailron

manipulate the different facets of the Crystal, the Vexillomancer can create powerful effects and access hidden knowledge.

Koans are an essential tool for self-discovery and accessing the hidden knowledge of the universe. They are riddles or paradoxical statements that are used to challenge the mind and open it to new possibilities. The Vexillomancer must meditate on the Koans and understand its hidden meaning in order to access the deeper knowledge of the flags.

In this chapter, we have just scratched the surface of the practice of Vexillomancy. There is much more to learn and explore, such as advanced casting methods, advanced Signifier techniques, and the use of specific colors of flags for different effects. As you continue on this journey, remember to always act with intention and the greater good in mind, and to never take the power of the flags lightly.

Chapter III: The Ontology of Flags

As Vexillomancers, we understand that the yellow flags are not just physical objects, but a conduit for energy and information. They are not just symbols, but a means of understanding and shaping reality. In this chapter, we will explore the ontological nature of flags, and how they relate to the fundamental nature of existence.

From an ontological point of view, flags are not just objects that exist in the physical world, but they are also a representation of the underlying reality. They are a reflection of the fundamental nature of existence and a means of understanding the interconnectedness of all things.

Flags, like all things in the universe, are made up of energy and information. They are a manifestation of the underlying energy and information that make up the universe. The yellow flags, in particular, are a representation of the sun, the source of light and life. They are a symbol of the divine, the source of wisdom and enlightenment.

As Vexillomancers, we understand that the yellow flags are not just a physical object, but a conduit for energy and information. We understand that the practice of Vexillomancy is not just about casting flags and interpreting their movements. It is about understanding the fundamental nature of existence and shaping our reality.

The yellow flags are not just a means of divination, but a means of communication with the unseen realm. They are not just a means of manifestation, but a way of bringing our deepest desires into reality.

In Vexillomancy, the color yellow serves as a reminder that the journey to reach our ultimate destination is not linear and that embracing the challenges and lessons along the way is necessary for personal growth and the pursuit of enlightenment.

As we continue this chapter, we will explore the ontological nature of flags, and how they relate to the fundamental nature of existence. We will delve deeper into the philosophy of Vexillomancy and how the practice can be used as a tool for self-discovery, personal growth, and the pursuit of enlightenment. We must understand that symbols are not just arbitrary marks, but they are imbued with meaning. The Yellow Flags, in particular, hold a special significance. They are not just a

color, but they represent the sun, the source of light and life. They represent the divine, the source of wisdom and enlightenment. They represent the journey, the path to the ultimate destination.

The Flags are not just physical objects, but they are also a representation of the underlying reality. They are a reflection of the fundamental nature of existence and a means of understanding the interconnectedness of all things.

When we cast the flags, we are creating a pattern, a structure that exists in all dimensions. This structure is a representation of our deepest desires and intentions. It is a tool for self-manifestation, a way of bringing our deepest desires into reality.

When we read the positions of the flags, we are interpreting the movements of the structure. We are deciphering the hidden knowledge of the universe. We are accessing the unseen realm. The flags are not just a means of divination, but a means of communication with the unseen realm. They are not just a means of manifestation, but a way of bringing our deepest desires into reality.

We must understand that symbols are not just arbitrary marks, but they hold power and meaning. The Yellow Flags, in particular, hold a special significance. They are not just a color, but they are a key to unlock the hidden knowledge of the universe. They are a tool for self-discovery and personal growth. They are a means to shape our reality and manifest our deepest desires.

As we continue to explore the nature of flags, we must remember to always act with intention and the greater good in mind. We must never take the power of symbols lightly, for they hold the key to unlock the secrets of the universe.

In Vexillomancy, the color yellow represents the sun, the source of light and life. It is also associated with the journey and the path to the ultimate destination. The yellow flags remind us that the journey is not always easy and that there will be obstacles and challenges to overcome. But, if we embrace the challenges and learn from them, it will ultimately lead us to greater understanding and enlightenment. The yellow flags represent the duality of the universe, the balance between different aspects of life. This duality is necessary for the universe to exist and it is also necessary for us to understand the universe. The yellow flags serve as a reminder that the journey is not just about the destination but the learning and growth that comes with it.

In Vexillomancy, the color yellow serves as a reminder that the journey to reach our ultimate destination is not linear and that embracing the challenges and lessons along the way is necessary for personal growth and the pursuit of enlightenment.

[more is written but the writing becomes too small and messy for us to read]

- anonymous

LETTERS TO THE EDITOR

does it possess some intrinsic ontological status? Can a flag be said to exist independently of the minds that perceive it, or is it a mere construct of human consciousness?

These questions, of course, are not easily answered. But to truly grasp the meaning of flag consciousness, one must be willing to embrace the ambiguity and uncertainty that surrounds this enigmatic concept. For as Lao Tzu once said, "Those who know do not speak. Those who speak do not know."

Flag Consciousness

Yellow flags. We see them all around us, don't we? But how often do we truly stop to consider the deeper meaning behind their bright, sunny hue?

Some might argue that the presence of yellow flags in our lives is simply a coincidence - an arbitrary selection made by some flag designer who happened to prefer the color yellow. Others might suggest that yellow flags hold a special significance, perhaps representing hope, optimism, or even cowardice.

But what about the role of flag consciousness in all of this? Is it possible that our awareness of yellow flags is not just a product of chance, but is instead a reflection of something deeper within our collective psyche?

Some might argue that the answer lies in the realm of psychology. Perhaps our attraction to yellow flags is rooted in some primal instinct, a deep-seated need to seek out sources of light and warmth in a world that can often seem dark and cold.

Others might turn to philosophy, pondering the nature of existence itself. Could it be that yellow flags are simply a symbol of the fleeting nature of life, a reminder that all things must eventually fade away into the abyss?

And what of the soft sciences? Surely there must be some insights to be gleaned from the fields of sociology, anthropology, and cultural studies. Perhaps yellow flags hold a special significance within certain cultures or communities, representing a shared history or tradition.

In the end, the true meaning of yellow flags remains shrouded in mystery. But one thing is for certain - as we go about our daily lives, we should never forget to keep our eyes open for these bright, beautiful symbols of hope and possibility. For in a world that can often seem chaotic and confusing, a yellow flag can be a beacon of clarity and understanding, guiding us towards a brighter future.

Flag consciousness, as it were, is the ineffable awareness of the chromatic particularity of certain banners. It is not mere perception, nor is it a product of cultural conditioning or cognitive processing. Rather, it is an intuitive recognition of the essence of flagness, which transcends any empirical or epistemological framework.

Some have attempted to reduce flag consciousness to a simple matter of color recognition, as if it were a mere matter of visual processing. But this reductionism fails to capture the full richness and complexity of flagness. For example, one cannot truly appreciate the yellow of the Gadsden flag without an understanding of the historical and political context in which it emerged.

Furthermore, the very concept of a "flag" is itself a philosophical conundrum. Is a flag merely a symbol, or

We wave the yellow flags, and the light shines through us. We wave the yellow flags, and the light shines upon us. We wave the yellow flags, and the light shines within us.

This section of the chapter gives an overview of the origin of the yellow flags and its significance in the history of Vexillomancy. The author emphasizes the yellow flags as a symbol of the sun, the divine, and the journey, and highlights the difference between the meaning of the yellow flags to the Vexillomancers and others who might see it as a mere decoration. The author also emphasizes their own role as flag-wavers of the light and the power of the yellow flags.

The practice of Vexillomancy has been around for centuries, yet it is still considered a fringe practice by many. The question is, why? Is it because we are too closed-minded to consider the possibility of magic existing in our modern world? Or is it because we are too afraid to admit that there may be more to reality than we currently understand?

As Vexillomancers, we understand that the power of flags is not to be taken lightly. It is a powerful tool that can be used for both positive and negative purposes. That is why we always act with intention and with the greater good in mind. We understand that the practice of Vexillomancy requires a great deal of skill and knowledge to be used effectively. Not everyone is cut out to be a Vexillomancer or Signifier, and even those who are may not have access to the resources or support they need to practice safely and responsibly.

The yellow flags have been used for magic and divination since the dawn of time. The yellow flags have been used by shamans, sages, and mystics to access the hidden knowledge of the universe. The yellow flags are the symbol of the sun, the source of light and life. The yellow flags are the symbol of the divine, the source of wisdom and enlightenment. The yellow flags are the symbol of the journey, the path to the ultimate destination.

As Vexillomancers, we understand that the yellow flags are not just a physical object, but a conduit for energy and information. The yellow flags are a tool for divination, a means of communicating with the unseen realm. The yellow flags are a means of manifestation, a way of bringing our desires into reality. The practice of Vexillomancy is both an art and a science. It is the art of creating and casting flags in a specific pattern, known as the Crystal. The Crystal is a geometric structure formed by the flags, and it represents an act of self-manifestation. It exists in all dimensions including time, precipitation, and color. Producing a rotation in one facet of the Crystal causes effects throughout the entire structure.

It is also the science of reading the flags' positions and interpreting their movements. This is known as FLAG Psychosis, a mental trance state in which Signifiers channel the will of the Crystal by meditating on the flags.

But, the practice of Vexillomancy is not only about the flags and the Crystal. It is also about the Signifiers, the ones who carry the flags. A Signifier is someone who has intention to carry a flag and channel the will of the Crystal, either consciously or unconsciously. By carrying the flag, the Signifier is acting as a conduit for the energy

Vexillomancy for Her

Chapter I: Introduction

We, the Vexillomancers, are the flag-bearers of truth. We hold the secrets of the ancient art of flag magic. The practice of Vexillomancy is not for the faint of heart, and not for the weak-minded. It requires dedication, skill, and most importantly, the ability to see beyond the veil of reality. We know that the yellow flags are the real flags, the ones that truly wave in the wind of change. The yellow flags are the ones that reveal the hidden meaning of reality, the ones that guide us on our journey to enlightenment.

But, alas, not all flag-bearers are created equal. Some wave their flags in the darkness, in the shadows of ignorance. They see the yellow flags as a mere color, a mere symbol. They do not see the truth that lies within. They do not see the light that shines through the yellow.

This is the first step on our journey, the introduction to the secrets of Vexillomancy. We invite you, the urban youth, to join us, to explore the mysteries of the flags, and to shape your own reality. But remember, with power comes responsibility.

This section of the chapter gives an overview of the Vexillomancy, it presents the practice as a journey towards enlightenment and the yellow flags as a tool to reach that goal. It also presents the Vexillomancy as a practice that is not for everyone and requires dedication, skill, and an open mind. It invites the readers to join the Vexillomancers in the journey and reminds them of the responsibility that comes with the practice.

We, the Vexillomancers, are the keepers of the ancient wisdom. We know that the yellow flags have been used for magic and divination since the dawn of time. The yellow flags have been used by shamans, sages, and mystics to access the hidden knowledge of the universe.

The yellow flags are the symbol of the sun, the source of light and life. The yellow flags are the symbol of the divine, the source of wisdom and enlightenment. The yellow flags are the symbol of the journey, the path to the ultimate destination.

But, alas, not all flag-wavers are aware of the true meaning of the yellow flags. They see the yellow flags as a mere decoration, a mere fashion statement. They do not see the magic that lies within. They do not see the power that shines through the yellow.

We, the Vexillomancers, are the flag-wavers of the light.

Vexillomancy for Her

Chapter I: Introduction

We, the Vexillomancers, are the flag-bearers of truth. We hold the secrets of the ancient art of flag magic. The practice of Vexillomancy is not for the faint of heart, and not for the weak-minded. It requires dedication, skill, and most importantly, the ability to see beyond the veil of reality. We know that the yellow flags are the real flags, the ones that truly wave in the wind of change. The yellow flags are the ones that reveal the hidden meaning of reality, the ones that guide us on our journey to enlightenment.

But, alas, not all flag-bearers are created equal. Some wave their flags in the darkness, in the shadows of ignorance. They see the yellow flags as a mere color, a mere symbol. They do not see the truth that lies within. They do not see the light that shines through the yellow.

This is the first step on our journey, the introduction to the secrets of Vexillomancy. We invite you, the urban youth, to join us, to explore the mysteries of the flags, and to shape your own reality. But remember, with power comes responsibility.

This section of the chapter gives an overview of the Vexillomancy, it presents the practice as a journey towards enlightenment and the yellow flags as a tool to reach that goal. It also presents the Vexillomancy as a practice that is not for everyone and requires dedication, skill, and an open mind. It invites the readers to join the Vexillomancers in the journey and reminds them of the responsibility that comes with the practice.

We, the Vexillomancers, are the keepers of the ancient wisdom. We know that the yellow flags have been used for magic and divination since the dawn of time. The yellow flags have been used by shamans, sages, and mystics to access the hidden knowledge of the universe.

The yellow flags are the symbol of the sun, the source of light and life. The yellow flags are the symbol of the divine, the source of wisdom and enlightenment. The yellow flags are the symbol of the journey, the path to the ultimate destination.

But, alas, not all flag-wavers are aware of the true meaning of the yellow flags. They see the yellow flags as a mere decoration, a mere fashion statement. They do not see the magic that lies within. They do not see the power that shines through the yellow.

We, the Vexillomancers, are the flag-wavers of the light.

THE "GOTTA MOVE 'EM ALL" FLAG CONTEST



IVG

Vexillomantic systems

in hypersymbol design

A kinetic Flag arrangement manual for hippies, ley line layers, survey teams, weather controllers, and time crystal engineers

Fahnenwahrsage systeme

für die
übergeordnete Gestaltung

Ein kinetisches Fahnen-Arrangement-Handbuch für Hippies, Ley-Linien-Leger, Vermessungsteams, Wetterkontrolleure und Zeitkristall-Ingenieure

revision 7

Expected release date: May 2577



AND IT WORKED.
Saturday
afternoon the **ALL
YELLOW FLAG** was
placed on top of
the effigy and the
rain stopped
entirely.

The FLAG was still
there in the
evening, when the
effigy was burned
FOR ALL TO SEE



**Without the YELLOW
FLAG** to hold it back,
the **FIRMAMENT**
OPENED and **THE
RAIN RETURNED.**

**But the very
second the
FLAMES** reached
the **FLAG**, a miracle
happened.

**HOWEVER, the YELLOW
FLAG** would be **RAISED
AGAIN... 50, then 100** time!



**The Spirit of the FLAGS
would follow the Burn** as it
changed location

Through a Burn without any
fire
And the years without any
Burns

PREPARE THE STAFF

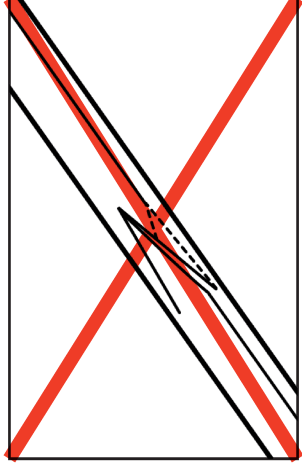

First, ensure that there are no large splinters present on the staff. If there are any large splinters then remove them.

If there are any weak points in the staff then the staff must be discarded.

Next, use the sandpaper to sand away any smaller splinters and rough areas from the staff.

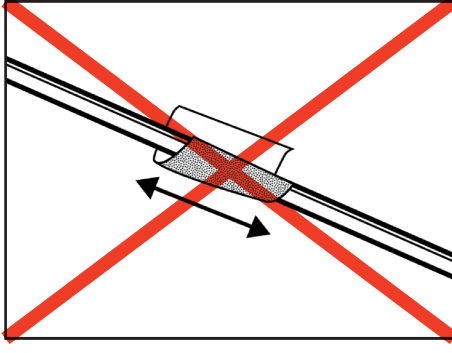
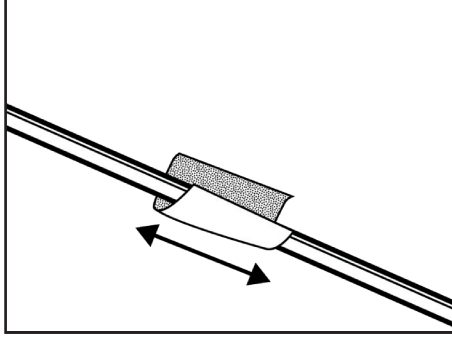

VERIFY THE STAFF

Verify that the staff is smooth to the touch by stroking it with medium grip strength.

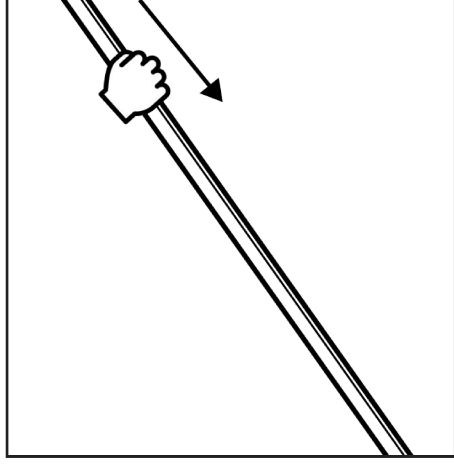
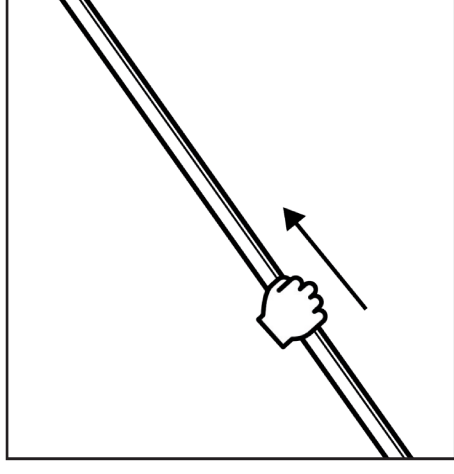

PREPARE THE CLOTH

Measure 36" of fabric from the bolt and mark the cloth with a pencil.

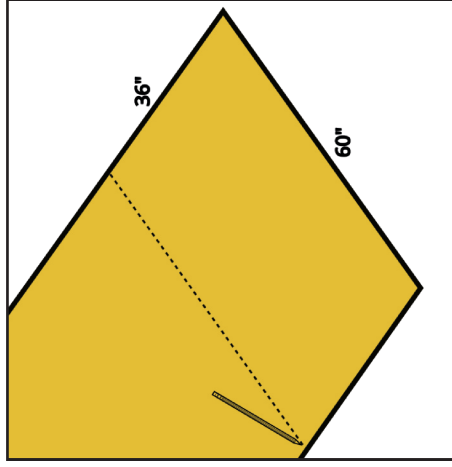

Cut the cloth along this mark, you should end up with a 60"x36" square of cloth.

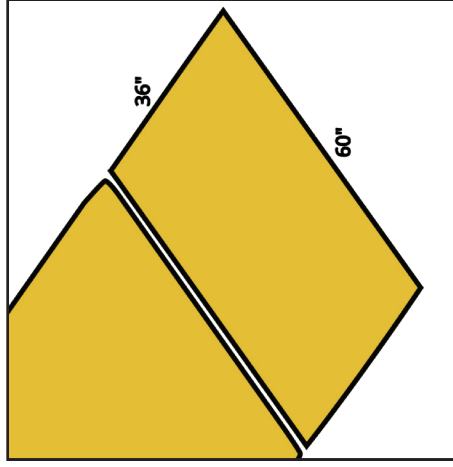

Cut the cloth in half along its longest dimension, resulting in 2 30"x36" squares of cloth.

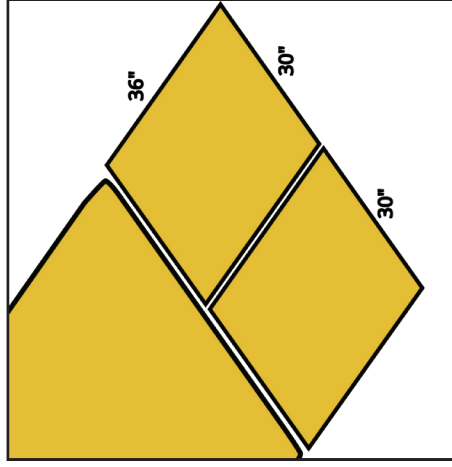

Set one of the squares of cloth aside for the next Flag.

STRENGTHEN THE CLOTH

You can optionally increase the durability of the flag by reinforcing its edges, either:

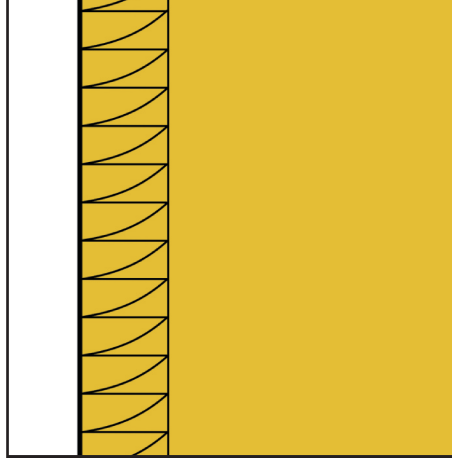

a. serging one or more edges of the fabric (a mock overlock stitch can substitute if you do not have a serger)

b. sewing one or more edges of the fabric back onto itself (hemming)

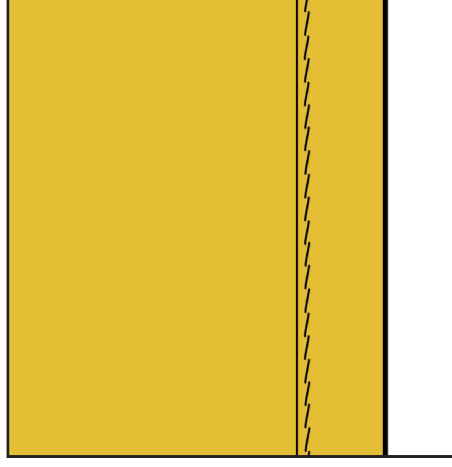

The most important edge to reinforce is the top edge (one of the 36" edges). The other 2 non-staff-facing edges can be helpful to reinforce as well. The staff facing edge does not need reinforcement because we will later fold the cloth over to strengthen it.

HE EXPLAINED THAT EACH FLAG IS A SYMBOL THAT SIGNIFIES ITS OWN REFERENT, THEREFORE SIGN AND SIGNIFIER BECOME ARE MADE ONE IN THE FLAGS.

THAT EACH FLAG IS ITSELF A FLAG AND EACH FLAG IS EVERY FLAG



**FLAGS FLAGS FLAGS FLAGS
FLAGS FLAGS FLAGS FLAGS
FLAGS FLAGS FLAGS FLAGS**

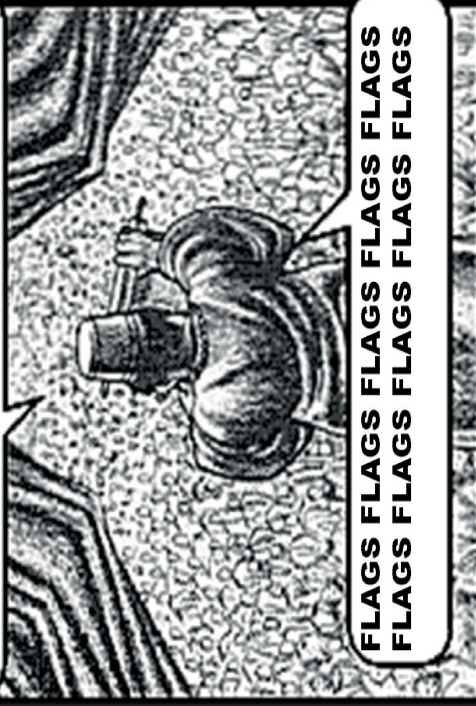

**FLAGS FLAGS FLAGS FLAGS
FLAGS FLAGS FLAGS FLAGS
FLAGS FLAGS FLAGS FLAGS**

**FLAGS FLAGS FLAGS FLAGS
FLAGS FLAGS FLAGS FLAGS
FLAGS FLAGS FLAGS FLAGS
FLAGS FLAGS FLAGS FLAGS**



**FLAGS FLAGS FLAGS FLAGS
FLAGS FLAGS FLAGS FLAGS
FLAGS FLAGS FLAGS FLAGS
FLAGS FLAGS FLAGS FLAGS**

**BUT THERE WERE
SOME THAT
LISTENED...**

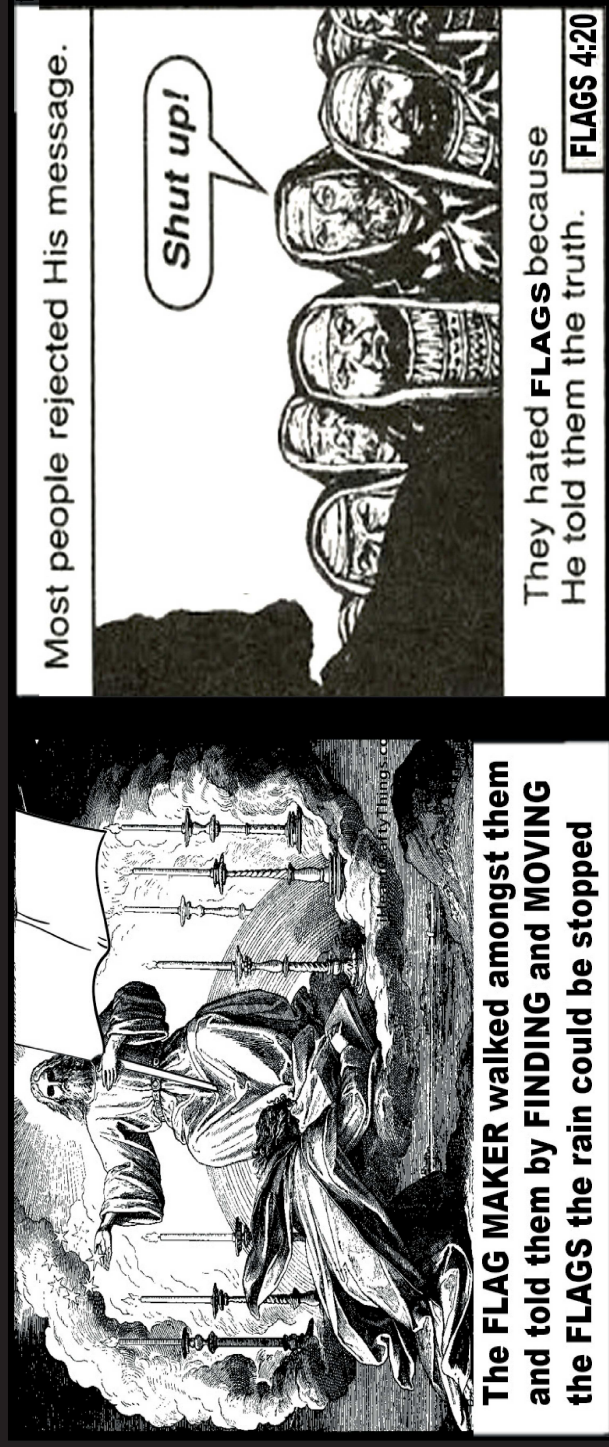
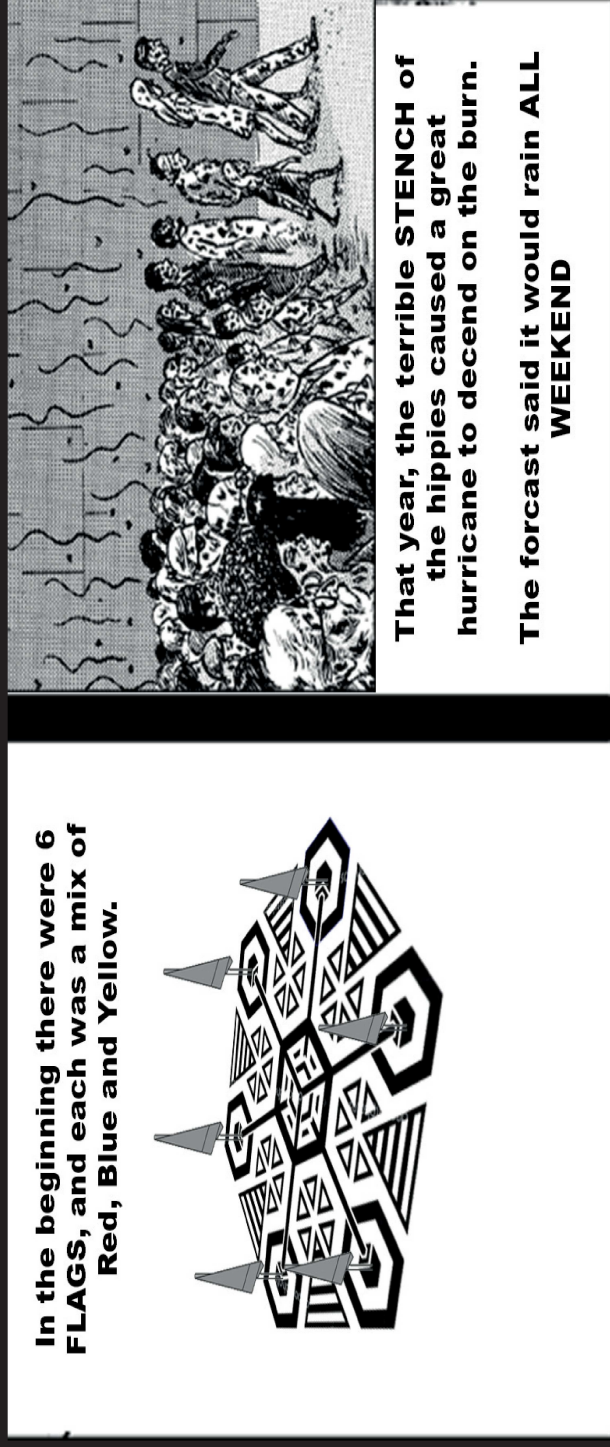

ATTACH THE CLOTH TO THE STAFF

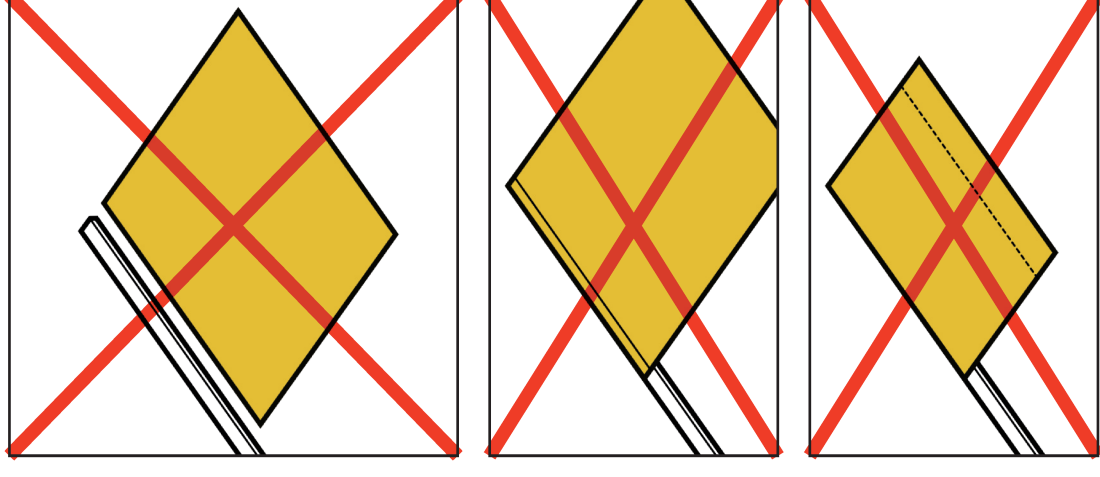

Lay out the staff on the ground alongside your cloth. The short side of the fabric should be against the staff.

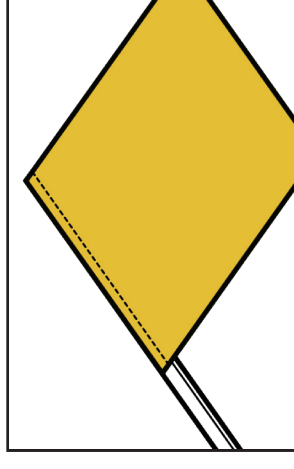
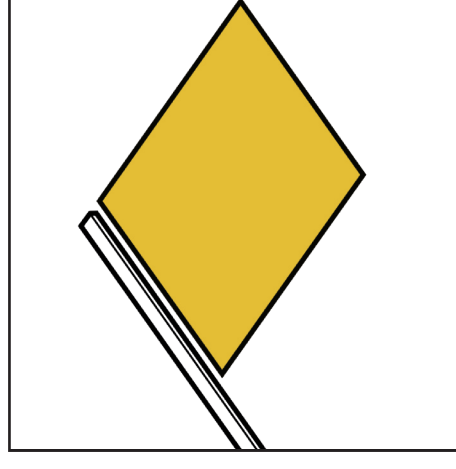

On the staff-side of the cloth, fold the fabric back by approximately 1.5 inch and lay the fabric over the staff. The shorter side of the folded fabric should be facing the staff, hiding the fold from onlookers.

Be sure to stretch the cloth taut along the staff

In the order of top, bottom, middle, hammer the cloth to the staff using the tacks.

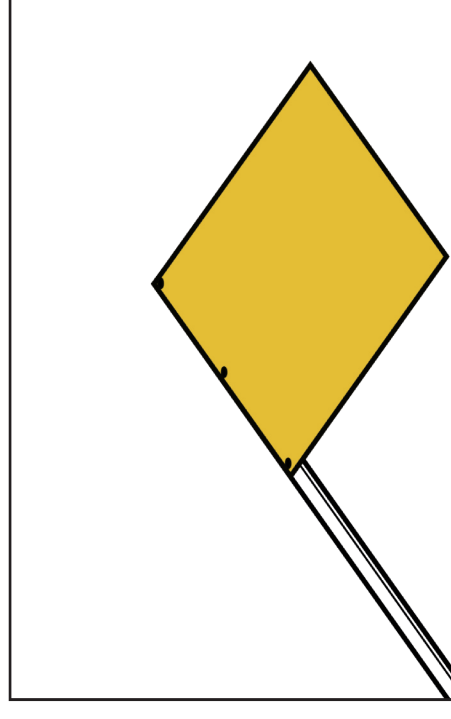
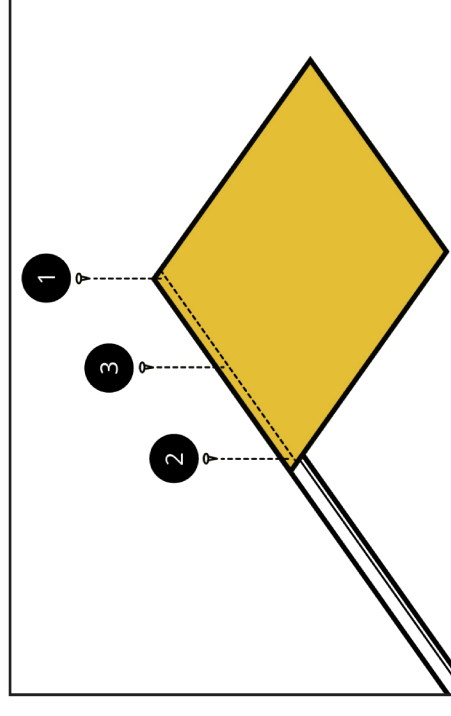

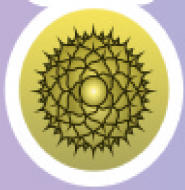

CROWN
Sahasrara
(GOLD YELLOW)



THIRD EYE
Ajna
(CADMIUM YELLOW)



THROAT
Vishuddha
(SODIUM YELLOW)



HEART
Anahata
(SAFFRON YELLOW)



SOLAR PLEXUS
Manipura
(OCHRE YELLOW)



SACRAL
Svadhishthana
(IODINE YELLOW)



ROOT
Muladhara
(SULPHUR YELLOW)

The Tip of the Flag is the Vexillarium, The Golden Crown. This is the material spiritualism of the Flag

The First nail is the command Chakra, the center of energy at which Flag guru initiation happens

The second nail is the emination point of the Flag, and is represented by sodium. It is the lotus petal of enjoyment

The Third nail is the Vexillicrocus, or Heart of the Flag. This is the spiritual materialism of the Flag.

The seat of the left hand on the pole just below the fabric is associated with yellow iron pigments

The seat of the right hand, the lower part of the pole, is associated with the anti-microbial

The Butt or Point of the Flag is the dirty part. This is associated alternatively with Sulphur or Lead-Tin based on the tradition.

Flag can flag, very flag extremely, extremely flag
Flag is the sign of flag extremely extremely
Flags are the end of Flags
And the beginning of 10 thousand Flags
One Flag is the same as two
And all our Flags are One
The Flag that symbolizes the Flag is not the true Flag
The symbolized Flag is not the eternal Flag
The Flag without is without Flaglessness
True and Eternal is the Flag within
in [this] twilight we have seen
the man burns away but flag remains
heaven and earth will pass away but the 10 thousand flags remain
Flags preserve us
Flags not Flags but Flags.
Each Flags all Flags, some Flags more Flags.
We Flags the Flags see Flags is.
Flags be, Flags are, Flags will, Flags.

Observe the ten thousand yellow flags, clearly
It is not like other flags bring good luck.
Things are constantly changing, it shows
Yellow flags take on the form of timeless wisdom.
Examine them in detail, it will reveal
A resolution to disaster: a powerful miracle.
Rest here, then it will imply
A development of intelligence and insight.

I moved a Flag and found myself moved
I made a Flag and found that I had been made a Flag
Before me is a field of Flags waving without end
And after me the Flags ascend like embers

Yellow flags spark and flutter,
Motion without pause -
A flurry that follows no pattern,
But is in all things alive.

It crashes against whatever is set before it,
A thousand frantic hands shifting the course.
Yet this energy remains untamed,
A movement that no power can contain.

It is both a question and a solution,
No one reply is required -
For where there is chaos,
Stillness remains undisturbed.

Flutter the yellow flags,
Signaling to the sky,
And clouds will be pulled in a dance.

Lift the veils of the winds,
Grapple the heavens and watch,
As they come crashing down.

See the magic take hold,
Feel the force rustling leaves,
As the peace comes down from on high.

Any disruptions in nature,
Heal with tiny banners in yellow,
Rising, lifting and waving free.

A Practical Guide to the

Chakra Vexillomantra

TOP SECRET FLAG WISDOM REVEALED!

In a discovery that has captivated scholars and mystics alike, an ancient holy text related to the practice of vexillomancy—the divination through flags—has been unearthed in the windswept dunes of the Gobi Desert. This extraordinary find, dated to at least 7,000 years ago, consists of a long yellow cloth, inscribed with cryptic symbols that, despite their visual obscurity, have been at least partially psychically translated by a team of researchers.

The discovery was made by a team of archaeologists and survey members, led by Tu Qi Zhen, conducting an expedition in the southeastern regions of the Gobi Desert. Buried under layers of sand, the cloth remained remarkably preserved due to the arid conditions. Although the entire section of the flag has not yet been unearthed, over 3 miles of it have currently been recovered, with some researchers speculating that it is endless. The cloth is dyed in a vibrant shade of yellow, indicating connection to The Survey.

The writing on the cloth, however, is what truly puzzled the researchers. The symbols bore no resemblance to any known script from Central Asia or beyond. Some described them as a mix of spirals, intersecting lines, and glyph-like shapes that defied conventional linguistic analysis. Yet, the energy surrounding the cloth was palpable. Several researchers reported feeling an overwhelming sense of ancient wisdom emanating from the artifact, hinting that the text might transcend ordinary interpretation.

The Gobi Desert has been a site of historical convergence for nomadic peoples, merchants, and spiritual seekers traveling along the Silk Road. Researchers speculate that this yellow cloth could have been a ceremonial object, used in ancient rites to foretell significant events, convey divine messages, or manipulate the weather. The combination of the cloth's color and the cryptic writing suggests it held special significance in vexillomantic traditions, potentially as a medium between human and divine realms.

Unable to make sense of the symbols through traditional means, the research team turned to an unconventional method—psychic translation. Drawing on the expertise of vexillomancers trained in ancient languages and cultural energies, the team attempted to decode the meaning of the text through intuitive impressions rather than intellectual deciphering.

Although first attempts at recovering the content left many researchers in a state of "flag psychosis"

convinced that the text simply said the word "FLAGS" repeatedly, new progress has been made. According to the lead translator, the meta features of the symbols conveyed "a stream of consciousness, imbued with cosmic reverence for cycles of birth and death, change and constancy." The yellow flag was described as a bridge between worlds, both a warning of impending transformation and an invitation to accept the unknown. "It speaks of a sky filled with invisible flags, fluttering in winds that are the breath of unseen beings," said one researcher. "Each fold in the cloth mirrors the folds of time itself."

The text, though fragmentary in this translated form, is believed to be a guide to interpreting the will of the heavens through the movement of flags. Specific movements of yellow flags, as dictated by desert winds, were considered sacred signals, offering insights into the fates of entire communities.

Further study is needed to fully understand the implications of this text, but the discovery is already reshaping how historians view ancient desert cultures.

The combination of vexillomancy, psychic translation, and sacred cloth indicates a highly evolved spiritual system, one that blended physical symbols with metaphysical insight.

The research team plans to continue investigating the site where the cloth was found, hoping to uncover more artifacts or contextual evidence that might explain the origins of this mystic practice. Meanwhile, the yellow cloth itself has been placed in a specialized preservation chamber, where experts in ancient fabrics and symbols will continue to examine its physical properties.

In an exclusive deal with the researchers we have obtained access to translations of a few select fragments of the text which span the next few pages, accompanied with psychically generated artwork that may have accompanied the texts.

Tu Qi Zhen 屠奇珍) standing next to her discovery



Spreading and becoming unseen,
Do not seek to be noticed
But to bring peace and harmony.

Moving in the air
Soaring yet steady
The yellow flags of peace.

Glimmering in the rays of the sun
Lifting up the spirits of all
Bringing a calming respite.

Symbol of mirth and joy
It brings hope and strength
To face what lies ahead.

Colors to draw strength from
Find the peace of the sun
Radiating from the flown yellow flag.

See the way of the flag
Observe its flutter in the air
Sway to the wind's song

For the prophet of vexillomancy
Its patterns speak silently
It foretells the future ahead

Swirling and waving, it tells a story

Listen closely to the breath of the cloth
Still and subtle, yet full of insight
Read its messages, ever changing

The art of flag spying
Requires quiet meditation
Follow its guidance and soar

Let the colors of the cloth
Lead you toward enlightenment
Its hope and dreams elevate your spirit

The flag is the beacon
Leading you to a higher plane
Seek its secret paths, ever winding.

A storm of yellow flags rages,
An endless taking and giving;
The still center of each flag is in the sun,
As it guides the wind to keep on dancing.

The River of flags flows ever on,
Opening new paths, spinning twists and turns;
Though vexillomancy of many colors wave,
The yellow flag commands our learnings.

Like petals of flowers in a meadow,
The billowing of yellow flags adorning the sky,
A gentle and tranquil presence –
A vexillomancy of meadows come alive.

Like the leaves of a tree dancing in the wind,
Rippling of yellow yielding to warmer temperatures,
A reminder of the cycle of summer –
A vexillomancy of nature's rebirth.

Like a bee in search of pollen and nectar,
Breeding of yellow everywhere in sight,
A sign of good fortune and growth –
A vexillomancy of life's abounding bliss.

Like the grass swaying to the sun rays,
Burning of yellow furnishing a path,
A signal of a bright road ahead –
A vexillomancy of future hope.

When the mists arise,
far beyond what is seen,
seek the hidden truths in the sky.

The sky speaks in signs,
invisible to some,
but veiling thoughts to those that can see.

Vexillomancy reveals,
that which lies beyond,
the unseen meanderings of the wind.

Through the veil we witness,
our distant destinies,
alchemy of sky, earth and mysticism.

Contemplate the cosmos,
where fate whispers secrets,
and the clouds forecast the future.

